

EH series

HITACHI

Reliable Solutions

Hitachi Construction Machinery Group

LANDCROS

Japanese Excellence—Reliable Solutions

EH3500AC-3

erialAngle



RIGID DUMP TRUCK

Model Code : EH3500AC-3

Nominal Payload with Standard Equipment : 181 tonnes (200 tons)

Target Gross Machine Operating Weight : 322 000 kg (709,888 lb.)

Engine : Standard : Cummins QSKTA50-CE

Rated Power 1 491 kW (2 027 PS, 2 000 HP)

Optional : MTU 12V4000 C21

Rated Power 1 510 kW (2 053 PS, 2 025 HP)



Hitachi EH AC-3
Promotion Movie.

Refined engineering and advanced Hitachi AC Drive system technology have created hauling capability well recognized in the surface mining industry.

The EH3500AC-3 continues to prove itself as an exceedingly capable and reliable solution to mine applications worldwide.





AC Drive Proven Performance & Economic Advantages

Hitachi engineered AC drives make your hauler a more valuable asset in your mining operation. Better performance, higher availability, and significant reductions in maintenance and operating costs - result in a lower cost per tonne and a higher return on your investment.

High-Powered Engine Selection

Standard Cummins QSKTA50-CE engine or optional MTU 12V4000 C21 engine is selectable.

Long Frame Life

A fabricated box section and rectangular frame rail construction provides superior resistance to bending and torsional loads. The top and bottom flanges eliminate cross member tie-in joints and provide a larger exposed center area for access to major components.

Tough Body

The Hitachi horizontal stiffener design minimizes stress concentrations by dissipating load shocks over the entire body length. Efficiently spaced stiffeners provide additional protection by minimizing distances between unsupported areas.

Well Matched: EH3500AC-3 & Excavators

Excavator	EX2600-7		EX3600-7		EX5600-7	
	BH	LD	BH	LD	BH	LD
Front						
Bucket	*17.0 m ³ (22.2 cu. yd.)	15.0 m ³ (19.6 cu. yd.)	*22.0 m ³ (28.8 cu. yd.)	22.0 m ³ (28.8 cu. yd.)	*34.0 m ³ (44.5 cu. yd.)	29.0 m ³ (38.0 cu. yd.)
Passes	6	8	5	5	3	4

BH : Backhoe LD : Loading shovel * : SAE heaped capacity

AC Drive Advantage



Hitachi Drive Control System Movie.

Hitachi AC drive technology provides superior truck performance with higher top speeds, better gradeability and stronger electric braking. Hitachi inverter modules provide high rigid truck controllability and efficiency. The Hitachi AC wheel motors do not have commutators and brushes, which improves truck performance by providing reduced maintenance costs, higher truck availability and higher travel speeds. These advantages result in more productivity and lower costs per tonne. Hitachi AC drive systems also power electric train locomotives world wide.

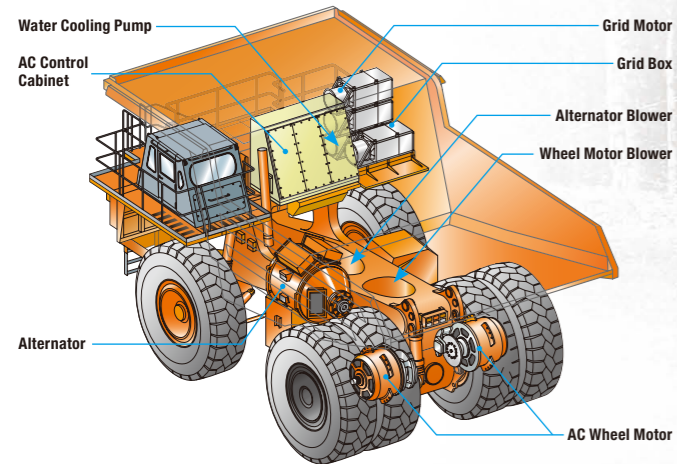

Hitachi Drive Control System

New Hitachi drive control system for optimal operational stability and performance as follows.

1. Slip / Slide Control System

If the system senses slipping or locking of rear wheels when traveling on slippery or frozen roads, it adjusts the torques of the wheel motors accordingly, bringing the truck more stable traveling.

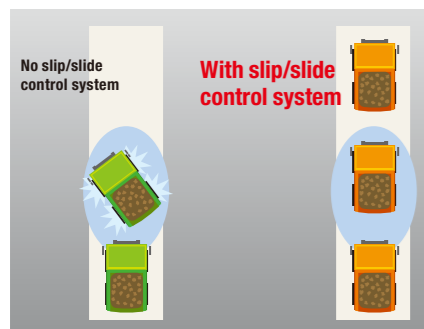

2. Pitch Control System

If the system senses pitching when traveling on bumpy roads or stopping abruptly, it adjusts the torques of the wheel motors accordingly to reduce pitching of the truck, resulting in better operating comfort and fewer load spillage.

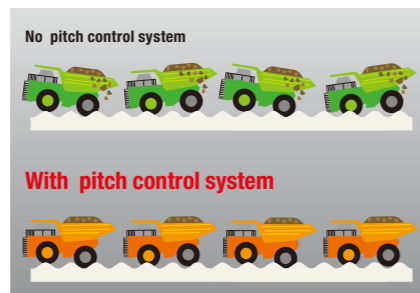

3. Side Skid Control System

If the system senses oversteer or understeer from the newly equipped sensors, it adjusts the torques of the wheel motors accordingly to control the side skidding. This brings the truck smoother movements and more stable traveling and steering.

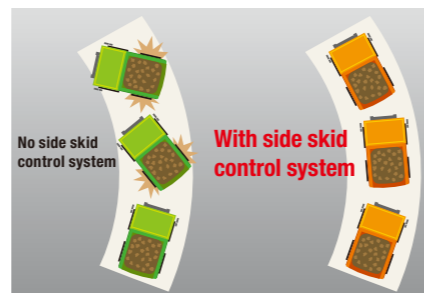

Note: This system is designed originally to enhance pleasant driving, so please drive at a safety speed or lower, and make periodic maintenance of the haul road.

AC Drive Control

Superior Electric Braking enables the driver to stop the truck using the electric brake pedal only with the exception of emergencies, because the AC drive control system applies the service brakes automatically just before the stopping, resulting in easy machine operation and longer time between service brake maintenance intervals.

Auto Cruise Control keeps vehicle speed constant within the set range by limiting the minimum vehicle speed.

Auto Retarding Control keeps vehicle downhill speed constant within the set range by limiting the maximum vehicle speed.

The AC Drive Wheel Motors

The Hitachi Double Path Tandem Planetary Design provides high efficiency. Better component and lubricant life is the result of holding the 1st carrier stationary and constantly cycling the lubricant through a cooler and filter.

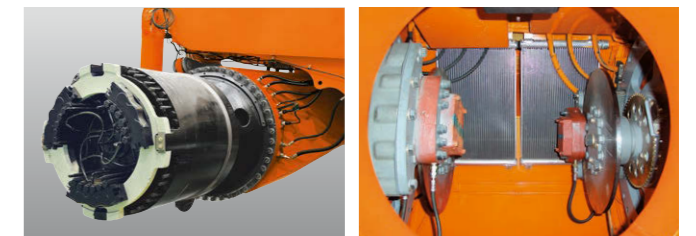

System to Improve Safety

Aerial Angle (Optional for Dump Truck)

Hitachi Dump Truck with Object Detect Assist



Aerial Angle Movie.

The dump truck Aerial Angle system is designed to assist in preventing collisions with obstacles. Aerial Angle has been newly implemented as an advancement and addition to the previous Peripheral Vision system. Obstacles within the front and surrounding areas of the machine are detected with warnings being activated by the system. The dump truck Aerial Angle has two modes. Stationary Mode detects any obstacles within the vicinity when the machine is stationary during dumping, loading, or when it is parked. Forward Mode warns the operator of the possibility of collisions during travel.

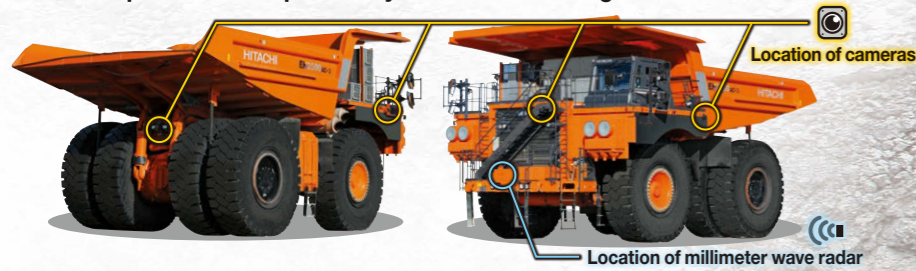

Loading area

Dumping area

Parking area

Hauling road area

Blue frame photos : Stationary Mode
Orange frame photos : Forward Mode

Warning:

- When driving the vehicle, be sure to perform a direct visual check all around the vehicle with your eyes.
- This System is an auxiliary system to assist the operator in driving, and its use should never substitute the use of common sense safety measures, direct visual observation, and professional judgment. Never solely rely upon this System to operate the vehicle.
- Failure to understand or correctly interpret the images displayed and the alert features of this System may lead to accidents involving serious personal injury or property damage. Operate this System properly by thoroughly reading Aerial Angle Operator's Manual and getting a good understanding of this System before using it.
- The images projected by this System from above are processed, synthesized camera images; therefore, the surroundings may not continuously appear on the monitor, objects may appear upside down or may not appear, or otherwise appear differently from visual observation.
- Depending on the surrounding environment or the subject of detection, the detection function of this System may not work properly.
- The brightness of the surroundings, weather, road surface conditions, and shape and material of objects detected may cause the alarm of this System to become non-operational or malfunction.
- Do not operate the monitor when you are driving the vehicle.

Note: There are countries the system cannot be used in due to local laws and regulations etc.

Stationary Mode

Screen Changeover Switch - Check the operating area with the choice of six different screens

The display layout of the previous Peripheral Vision system has been improved and now includes an additional screen (a total of six screens). This provides greater convenience allowing views to the sides as well as a birds-eye view of the machine itself.

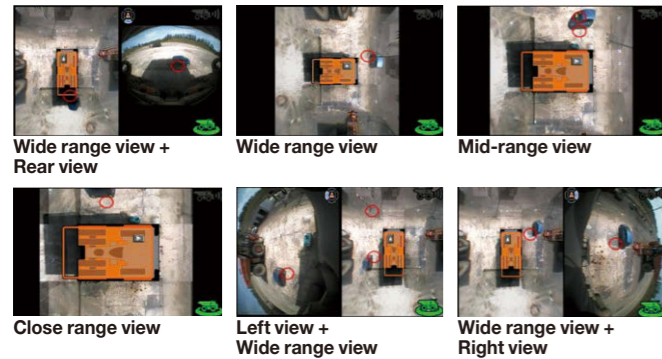

Obstacle Detection (When Stationary) - Supports safer checks before operating

The camera places markers on the screens as it detects obstacles. Red markers indicate any obstacles in the immediate vicinity of the machine, whereas yellow markers indicate obstacles further away. The markers will continue to follow obstacles until they no longer appear on the screen and have been avoided. This system enables the operator to check for outside obstacles on-screen without having to leave machine. The color of the machine's icon will change red when an obstacle comes underneath the machine to warn the operator.

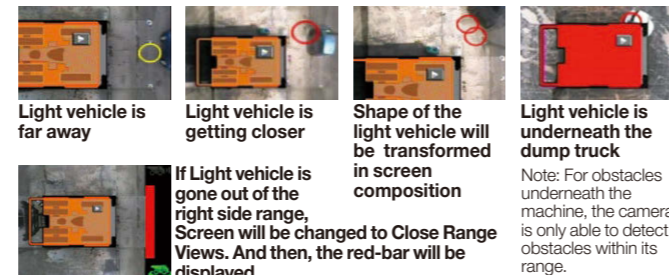

Forward Mode

Obstacle Detection (While Traveling) - Reduces collision risks during forward travel

Obstacles to the front and their distance from the machine are detected by a millimeter-wave radar. A warning will be activated when another machine in front comes too close. This warning notifies the operator by a buzzer sounding as well as being showing on-screen. Warnings are set at two distance ranges depending on the position of the machine in relation to obstacles.

The system adjusts the warning activation distance depending on the current gross laden weight of the vehicle. The system detects the wheel rotation direction and enables or disables the warning accordingly. (This is activated only during forward travel.)

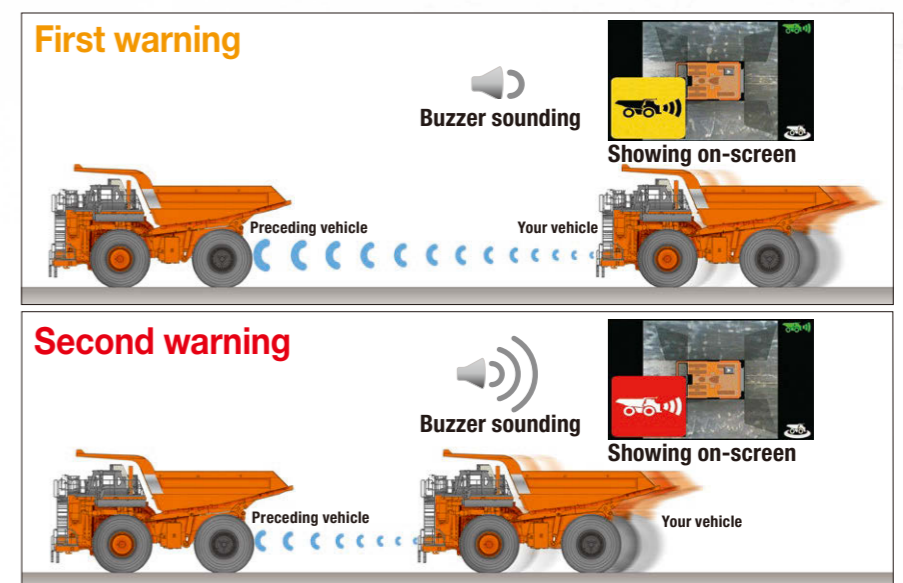

Ease of Operation



Superior Suspension

The Hitachi trailing arm suspension system delivers excellent maneuverability, even at higher speeds. The trailing arm layout offers greater ease of servicing while improving truck performance compared to suspended king-pin designs. The pivot mounting of the trailing arm design allows only axial input to the strut and allows wheel movement to the vertical plane only.

Features:

- Lateral forces that act on the front wheels are minimized, resulting in reduced tire scuffing.
- Dynamic friction (side-wall force) within the strut is low due to the features of the trailing arm suspension design, allowing the use of a lighter strut engineered to a smaller diameter and longer stroke.
- The necessary frame bulk (horse-collar structure) needed to mount a suspended king-pin is non-existent.
- The elimination of the “horse-collar” member provides greater engine access.

- The NEOCON strut used with the trailing arm suspension, improves operator and component isolation, provides better hauler stability and predictable operational control.
- Locating the king-pin close to the wheel assembly and at a slight angle results in low “Dry Park Steering” effort.
- Development of the compressible media, NEOCON-E™ fluid (proprietary, silicone based) for use in the suspension strut with Helium gas, results in an improved energy absorption (isolation) system and an improved energy release (stability) system that responds favorably whether traveling empty or loaded in a wide range of ambient temperatures.

The trailing arm suspension design allows the front struts to be removed and installed without removing the front brakes or tires. This means fewer tools and less labor time are required, resulting in less downtime and higher productivity.

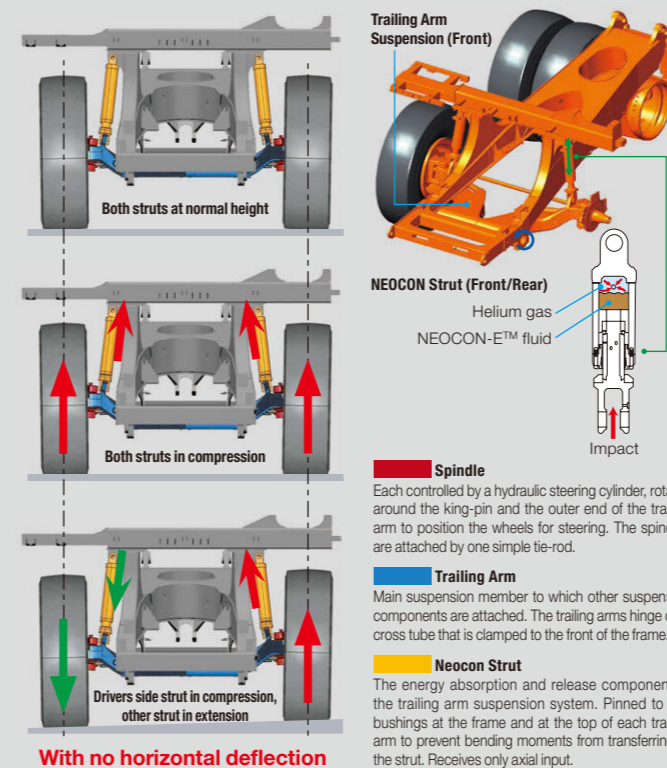

The Fast Filling System

The fast filling system, provided standard on the left side of the radiator, allows direct access at ground level for fast feeding of coolant, grease, hydraulic oil and engine oil. (Couplers are optional.)



Electric Drive Enables Lower Diesel Fuel Consumption

Trolley System (Optional)



Hitachi Trolley Movie.

Power supply from an overhead line provides powerful and relentless travel on slopes. Switch between the on-board power source and an external power line smoothly and easily. Comfortable, stress-free operation.

Difference of Energy Flow between Trolley and Diesel Truck

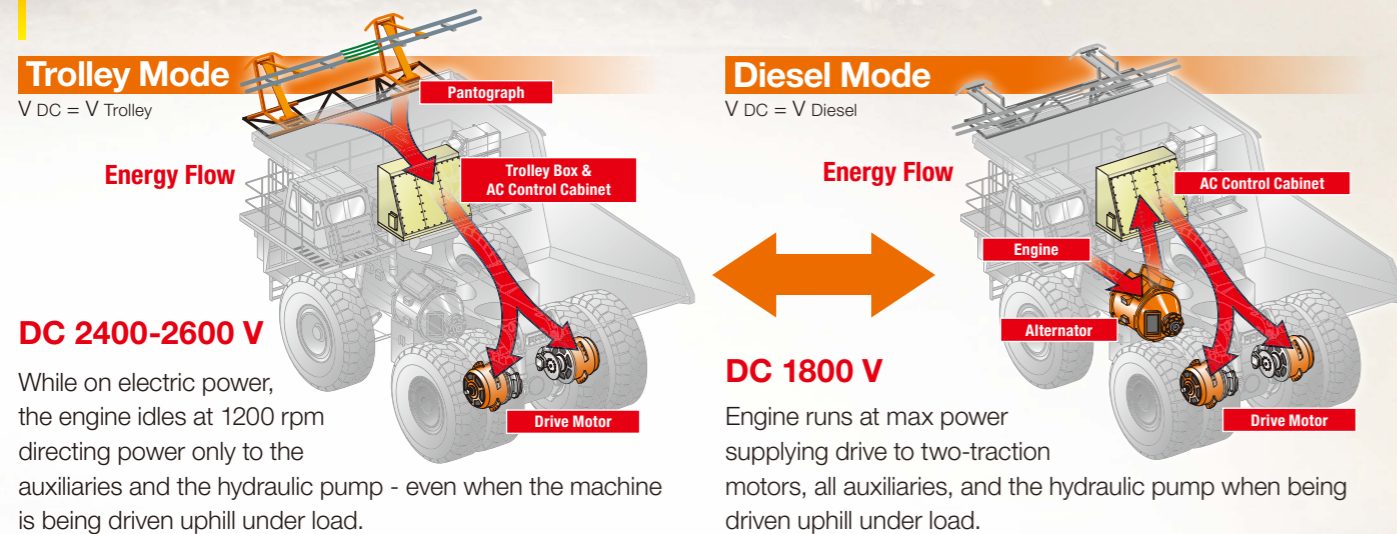

Benefits of the Trolley System

- Higher speeds during loaded hill climbing - faster than in Diesel mode (Travels at approx. twice the speed of a large-motor vehicle in Diesel mode) ➤ **Shorter cycle times, higher productivity**
- Lower diesel fuel consumption
High-efficiency trolley travel thanks to the high-voltage DC (2400-2600 V) system ➤ **Lower running costs, greater economy**
- Less engine stress leads to longer engine life ➤ **Lower running costs and greater economy and productivity due to less frequent engine overhauls**
- Lower exhaust emissions and lower engine noise ➤ **Environmental friendliness**
- Development of pantographs specifically for dump trucks ➤ **Reduces risk of damage due to vibrations and uses carbon-metallic contact strips**
- Body raising prohibited during trolley travel ➤ **Safer operation (electric shock prevention)**
- Low engine RPM during trolley travel (1,200 RPM) ➤ **Reduces noise inside cab**



TLA (Trolley Line Assist : Optional)

Operators can check the overhead trolley wire and pantograph from the Aerial Angle monitor.

1. Positioning Assist



Before entering the trolley section, this function assists the operator in aligning the truck with the trolley line.

2. Trolley Line Assist

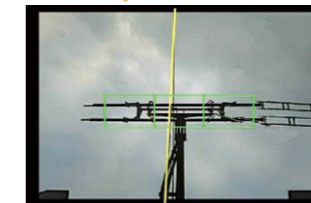

During trolley mode, this function assists the operator to drive within the contact range of the pantograph and trolley line.

These functions make driving the trolley trucks easier.

Comfortable Space



Ample legroom

Drink holder

Foot rest

Net pocket

Front pocket

Front tray with edge block

Drink holder

Net pocket

Drink holder

Document holder



2-LED room lights

Rear tray with edge block

Coat hook

Note: Photo may include optional equipment, accessories, and all standard equipment with some differences in color and features.

HI-TECH ROPS/FOPS Cab

The HI-TECH ROPS/FOPS cab has been equipped with a Hitachi controller and a large centrally mounted, color Liquid Crystal Display (LCD) as used in Hitachi large sized excavators. Double wall construction of 11 gauge inner and outer steel panels produces a more structurally sound cab. A three-point rubber isolation-mount arrangement minimizes vibration to the operator compartment.



Excellent Vision with Air Conditioning Maintains a Comfortable Operating Environment

Additional A/C leg room vents are provided within the cab. These help to keep the lower leg room areas warm or cool depending on conditions providing a more comfortable working environment for the operator.



A new vent positioned for the lower legs.

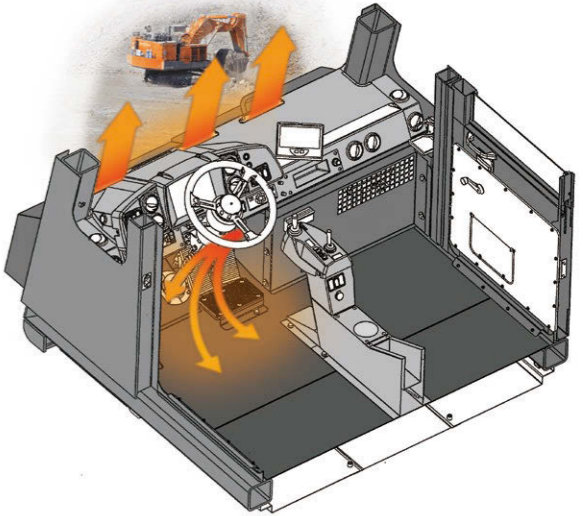

Machine Condition Monitoring



Consolidated Solution for Construction Sites

- “Every month” Receive operation reports with advice via e-mail
- “Machine emergency” Receive Emergency Alarm notifications via e-mail

ConSite is a consolidated solution service that links you to your machines on the construction site.

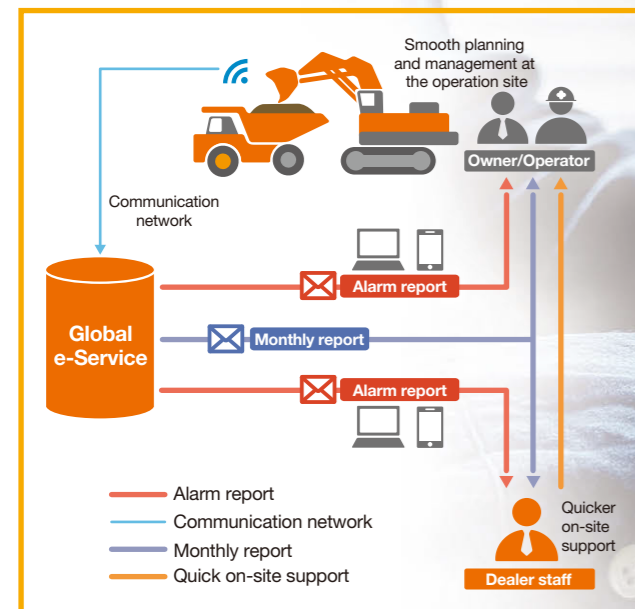

Data Report Service - Monitor Your Machines Closely with ConSite

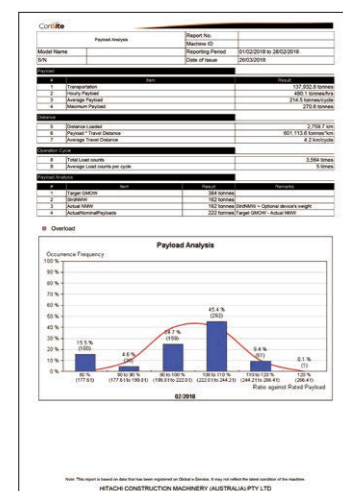

Payload analysis

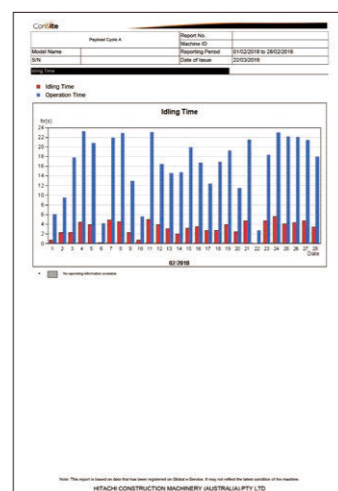

Idling time

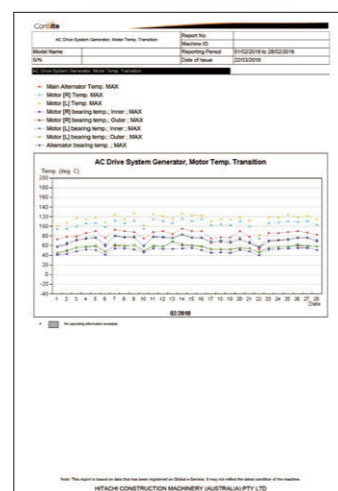

AC Drive components temperature



The report can be viewed on laptops, desktop computers, smartphones and tablets.

A. Monthly Report

A detailed report of the operational status for each machine will be sent to the registered e-mail addresses every month.

Benefits:

1. Monthly operational information helps you to analyse the operational efficiency of your machine and improve overall machine-operation status.
2. Each machine's operational information can be shared with Hitachi authorized dealers, enabling a stable operation for your machine.

Key items included in the report

- Truck payload summary
- Truck cycle summary
- AC drive components temperature
- Fuel consumption & operation efficiency
- Major components oil temperature
- Various advice & comments

B. Alarm Report

If the machine's alarm goes off and the problem requires urgent attention to prevent downtime, an emergency alarm report will be sent to the registered e-mail addresses.

Benefits:

1. Information of an alarm requiring urgent attention can be shared by the operator and owner, so that the necessary measures can be taken.
2. Alarm information can be shared with your dealer as well, to enable smoother coordination and reduce your machine's downtime.

Key items included in the report

- Model name / S/N
- Hour meter
- Alarm code / name
- Recommended action
- Position

Warning:

- The data report service is available on machines equipped with the communication terminal.
- Contact Hitachi authorized dealers for the details of Data Report Service and machine models that are supported.
- The communication ability may depend on the situation of the worksite. Please confirm if your machine is currently communicating before having this service.
- Under no circumstances shall Hitachi Construction Machinery Co., Ltd. and/or Subsidiaries and its Dealers be held responsible or liable for any communication line failure, interruption, delay in operation or transmission or any other cause of action.

SPECIFICATIONS

ENGINE

Standard

Model	Cummins QSKTA50-CE
Type	4 Cycle Diesel w/ MCR fuel system
Aspiration	2 stage Turbocharged & Low Temperature Aftercooled
Emission Certification	U.S. EPA Tier 2
Rated power @1 900 min ⁻¹ (rpm)	
ISO 14396	1 491 kW (2 027 PS, 2 000 HP)
Maximum Torque @1 500 min ⁻¹ (rpm)	
.....	7 871 N.m (803 kgf.m)
No. of Cylinders	16
Bore & Stroke	159 x 159 mm (6.26 in. x 6.26 in.)
Displacement	50.3 L (3,070 cu. in.)
Starting	24 Volt Electric

Optional

Model	MTU 12V4000 C21
Type	4 Cycle Diesel w/ DDEC
Aspiration	1 stage Turbocharged & Low Temperature Aftercooled
Emission Certification	Not Certified
Rated power @1900 min ⁻¹ (rpm)	
ISO 14396	1 510 kW (2 053 PS, 2 025 HP)
Maximum Torque @1 500 min ⁻¹ (rpm)	
.....	8 199 N.m (836 kgf.m)
No. of Cylinders	12
Bore & Stroke	165 x 190 mm (6.50 in. x 7.48 in.)
Displacement	48.8 L (2,978 cu. in.)
Starting	24 Volt Electric

Consult your Hitachi dealer for U.S. EPA Tier 4 Final / Euro Stage V engine options.

ELECTRIC DRIVE

HITACHI AC-Drive System

AC Control Cabinet

Rectifier	
Number of units	1
Rated capacity	1 340 kW (1 822 PS, 1 797 HP)
IGBT Inverter	
Number of units	2
Rated capacity per unit	800 kVA
Chopper	
Number of units	2
Rated capacity per unit	1 300 kW (1 768 PS, 1 743 HP)

Equipped with reliable water cooling system. Pressurized cabinet to reduce dust. Equipped with lockable doors for safety. Equipped with small inverters to provide Grid motors and Blower motor with adequate AC current. Uniquely constructed for the Rigid Truck application

Alternator

Number of units	1
Capacity	1 500 kVA at 1 900min ⁻¹ (rpm)

Equipped with an auxiliary alternator that provides AC current to Grid motors, Blower motors, and Control cabinet coolant pump. Air cooled by an AC drive blower.

AC Wheel Motor

Number of units	2
Capacity per unit	620 kW (843 PS, 831 HP)

Air cooled by an inverter controlled AC drive blower.

Grid Box (Electric Brake)

Number of modules	4
Capacity per unit	625 kW (850 PS, 838 HP) (short time)

Equipped with inverter controlled variable speed cooling fan.

Axle

Planetary Ratio	35.2 : 1
Maximum Speed (Continuous)....	56 km/h (35 mph)

TIRES

Front and Rear

37.00R57 (standard)	736.6 mm (29 in.)
40.00R57	736.6 mm (29 in.)

Rim Width

Tire manufacturers offer tires having a range of capabilities suitable for a variety of applications. For high performance hauling it is important to consult with the tire manufacturer to choose a tire that is best matched to truck TGMOW, travel speed and customer specific jobsite conditions. Jobsite condition severity, may result in a reduced truck payload and travel speed recommendation.

ELECTRICAL SYSTEM

Twenty-four volt system. 140 ampere Cummins engine driven or 260 ampere MTU engine driven alternator. Four 245H52, 12 volt, heavy duty batteries connected in series/parallel.

BODY CAPACITIES

Struck (SAE)	80.4 m ³ (105.2 cu. yd.)
Heaped 3:1	105 m ³ (137.3 cu. yd.)
Heaped 2:1 (SAE)	117 m ³ (153 cu. yd.)

Body capacity and payload subject to change based on customer specific material density and application.

STEERING SYSTEM

Closed-center, full time hydrostatic power steering system using two double-acting cylinders and a variable displacement piston pump. Hitachi accumulators provide supplementary steering in accordance with ISO 5010 (SAE J1511), supplying a constant steering rate under all conditions. A tilt/telescopic steering wheel with 35 degrees of tilt and 57 mm (2.2 in.) telescopic travel is standard.

Turning Diameter (ISO 7457)	29.3 m (96 ft. 2 in.)
-----------------------------------	-----------------------

HYDRAULIC SYSTEM

Two (2) Hitachi three-stage, double-acting cylinders, with electronic controlled cushioning in retraction and extension, containing dual rod seals and urethane energized scrapers, inverted and outboard mounted. A tandem piston pump combines with four position electronic pilot controlled hoist valve. The electrical controller is mounted to the shift tower.

Body Raise Travel	59.0 degrees
Body Raise Time	17.5 sec
Body Down Time (Float)	15.0 sec

BRAKE SYSTEM

Brake system complies with ISO 3450 (SAE J1473).

Service Brake

Service braking for the EH3500AC-3 is made up of front and rear hydraulically applied brakes and the electric brake.

Front Axle – Dry Disc

Disc Diameter Each (2 discs/axle, 3 calipers/disc).... 121.7 cm (4 ft.)

Rear Axle – Dry Disc

Disc Diameter Each (2 discs/axle, 3 calipers/disc).... 109 cm (3 ft. 7 in.)

Secondary

Two of front hydraulic, rear hydraulic and electric brake within the service brake system provide modulated reserve braking capability. Both front and rear hydraulic brakes are automatically applied when loss of pressure is detected.

Parking Brake

This system is designed to use spring applied, hydraulically released brake calipers to hold the truck stationary.

Electric Brake

The Electric Brake is used for usual operating brake for the EH3500AC-3. The Hitachi AC Drive system provides all necessary truck speed control, including speed reduction to 0 km/h (0 mph) travel speed when the electric brake pedal is depressed. Also, the rear service brakes automatically apply at speeds below 0.5 km/h (0.3 mph) if this pedal is depressed.

Maximum dynamic braking (Standard).... 2 800 kW (3 807 PS, 3 755 HP)

Load/Dump Brake Apply

Through activation of a switch by the operator, a solenoid is energized, sending full brake pressure to apply the rear Dry Disc brakes. For use during the load and dump cycles.

SPECIFICATIONS

WEIGHTS (Approximate)

Net machine weight stated below includes standard equipment. Net machine weight changes will directly affect the Nominal Payload.

With Standard 37.00R57 Tires

Chassis with Hoist & Body Parts	118 000 kg (260,145 lb.)
Body Excluding Body Parts	23 000 kg (50,706 lb.)
Net Machine Weight	141 000 kg (310,852 lb.)

The Net Machine Weight specification includes operator and 100 % fuel.

Nominal Payload	181 tonnes (200 tons)
Target GMOW	322 000 kg (709,888 lb.)

Weight Distribution	Front	Rear
Empty	48 %	52 %
Loaded	33 %	67 %

With Optional 40.00R57 Tires

Chassis with Hoist & Body parts	123 000 kg (271,169 lb.)
Body excluding body parts	23 000 kg (50,706 lb.)
Net Machine Weight	146 000 kg (321,875 lb.)

The Net Machine Weight specification includes operator and 100 % fuel.

Nominal Payload	178 tonnes (196 tons)
Target GMOW	324 000 kg (714,298 lb.)

Weight Distribution	Front	Rear
Empty	48 %	52 %
Loaded	33 %	67 %

Note:

Body parts mean assembled standard parts to the body, such as mud guards, body pads, rock ejector bars and fasteners.

Note:

The Nominal Payload specification is calculated using the Hitachi Loading Policy. Specific job site requirements may result in an adjustment to the Nominal Payload weight. Consult your Hitachi dealer for a truck configuration which will match your haulage application.

HI-TECH ROPS/FOPS CAB

New HI-TEC ROPS/FOPS Cab

ROPS complies with ISO3471 and FOPS complies with ISO3449. A three-point rubber isolation mount arrangement to the high-arch cross member minimizes vibration transfer to the operator compartment. New wider cab with double full size seat available and enough trainer's leg space brings comfortable operating and training.

Monitoring System

A new Hitachi system monitor provides display information and diagnostics of all onboard systems and controls which include the engine and Hitachi AC drive. Data links offer complete integration, while a color Liquid Crystal Display (LCD) clearly details machine functions. Downtime is minimized with faster and more reliable troubleshooting and analysis. A new Hitachi load monitoring system offers benefits such as better equipment utilization on the jobsite, accurate unit and fleet production results, and benchmark unit statistics against fleet results. Cycle time, distance and cycle count can all be measured and recorded as information that can help in developing higher productivity. The Hitachi load monitoring system is fully integrated with the Hitachi vehicle monitoring system and display interface, avoiding potential failure or error common in aftermarket systems.

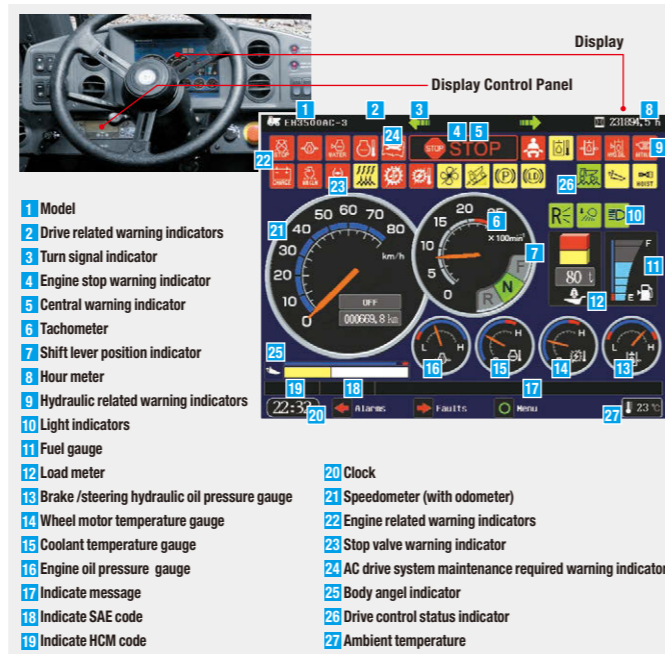

Camera Monitoring System

Included as standard safety support equipment, an analog monitor has been mounted to the dashboard to display live camera information of the rear and right front area.

SUSPENSION

Front Suspension

Independent trailing arms make up the front axle. NEOCON struts containing energy-absorbing gas and compressible NEOCON-E™ fluid are mounted between the trailing arms and frame. Inherent in the NEOCON strut design is a variable damping and rebound feature.

Rear Suspension

"A" frame structure, integral with axle housing, links the drive axle to the frame at forward center point with pin and spherical bushing. A track rod provides lateral stability between the frame and drive axle. Heavy-duty rear-mounted NEOCON struts containing energy-absorbing gas and compressible NEOCON-E™ fluid suspend the drive axle from the frame. Integral variable damping and rebound feature included.

FRAME

Full fabricated box section main rails with section height tapered from rear to front. Narrow at the rear to support the load and wider at the front allowing truck stability and excellent engine access for servicing. One piece top and bottom flanges that eliminate cross member tie in joints and provide a large exposed center area for access to major components. Large radii at frame junctions are blended and ground to minimize stress concentrations. Weld joints are oriented longitudinally to the principal flow of stress for greater durability and more strength. The new "bolt-on" High Arch Design requires less assembling time and no welding. The design provides higher structural quality and better serviceability during engine overhaul.

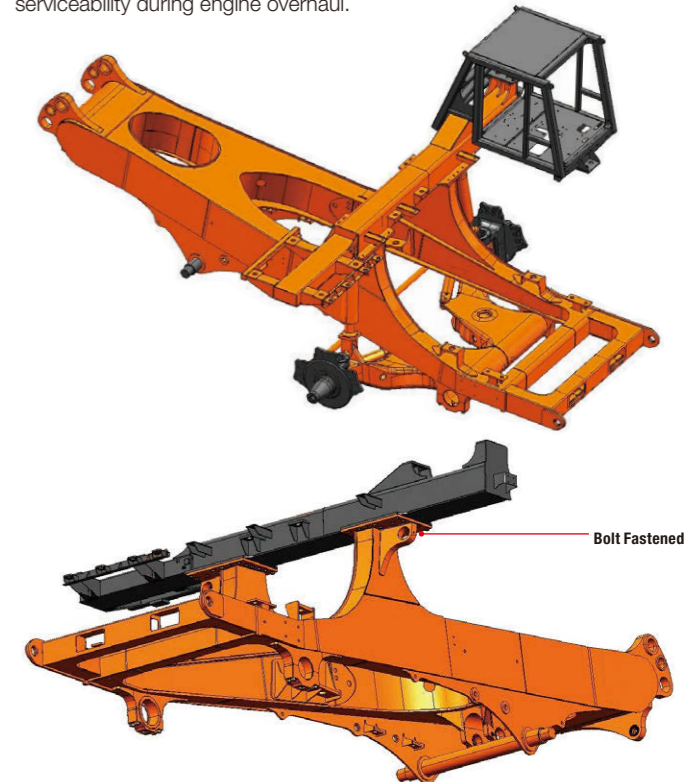

SPECIFICATIONS

BODY

An extended canopy protects service deck area. High tensile strength 400 BHN abrasion resistant alloy steel is used in thicknesses indicated below:

Floor	16 mm (0.63 in.)
Front	9 mm (0.35 in.)
Sides	9 mm (0.35 in.)
Canopy	6 mm (0.24 in.)
Corners	12 mm (0.47 in.)

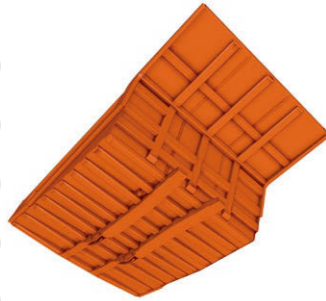

High strength 690 N/mm² (100 000 psi) alloy steel is also used for the canopy side members and floor stiffeners. The body is rubber cushioned on the frame.

Optional Body Liners

Floor & Corners	12 mm (0.47 in.)
Sides & Front	6 mm (0.24 in.)
Canopy drop edge	6 mm (0.24 in.)

Special plate thicknesses and partial plates are available.

SERVICE CAPACITIES

Crankcase (Includes Filters): Cummins	200 L (52.8 gal.)
Crankcase (Includes Filters): MTU	190 L (50.2 gal.)
Engine Cooling System: Cummins	531 L (140.3 gal.)
Engine Cooling System: MTU	543 L (143.4 gal.)
Fuel Tank (Standard)	2 010 L (531.0 gal.)
Fuel Tank (Optional)	3 640 L (961.6 gal.)
Hydraulic System	750 L (198.1 gal.)
Planetary Drives (L & R)	218 L (57.6 gal.)
Front Wheels (L & R)	17 L (4.5 gal.)
Windshield Washer	20 L (5.3 gal.)
Main Accumulator	70 L (18.5 gal.)

HITACHI BODIES

Tough Body Structure

Designed by Hitachi for long lasting strength and productivity. Hitachi offers customized solutions to match specific load and haul applications. Optional bodies and parts are engineered on request.

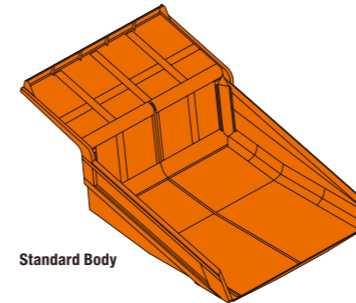

Standard Body

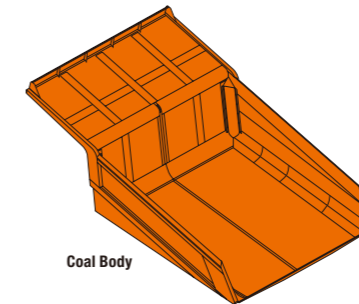

Coal Body

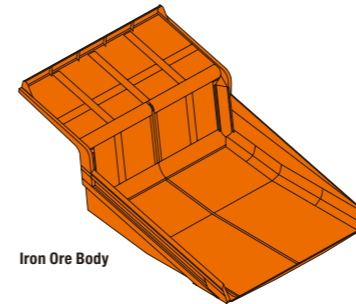

Iron Ore Body

Standard Body

The Hitachi standard body is designed to accommodate the needs of popular mid-range material densities and the most popular loading machines. Various options, such as liners, spill guard, extended canopy are available.

Coal Body (Optional)

The Hitachi coal body has been designed for low material density, small fragmented, low abrasive material. This coal body offers excellent material shedding, low empty weight and large capacity.

Iron Ore Body (Optional)

The Hitachi iron ore body has been designed for use in rugged iron ore mining applications. The body has been designed for high density material and optimized loading and dumping.

Customized Body (Optional)

Upon request and approval, Hitachi will design bodies to suit special mining applications.

Heated Body (Optional feature)

Heated Body is an optionally available feature for the STD, Coal, Iron Ore and other Customized Hitachi AC-3 Trucks Bodies. The heating system uses exhaust gas to warm the body as shown in the illustration in RH. Use of the heated body decreases the amount of carry backs that results in greater productivity.

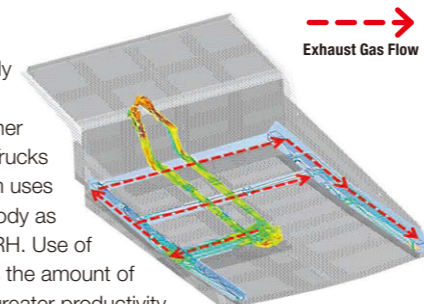

Exhaust Gas Flow

HITACHI LOADING POLICY

Operational Benefits

Haulroad Safety

Truck loading within the limitations of the Hitachi Loading Policy will result in designed and certified operational performance of the steering, brake and ROPS systems of the truck.*

Efficient Productivity

Truck loading within the limitations of the Hitachi Loading Policy will result in optimizing the fuel economy and travel speed performance to which the truck was designed to.*

Availability and Maintenance

Lower maintenance costs and higher availability can be achieved if truck loading is within the limitations of the Hitachi Loading Policy.*

*Hitachi recommended maintenance is required.

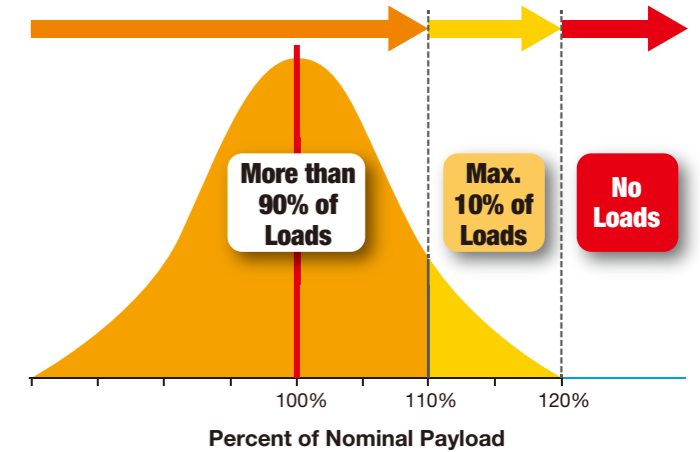

- 1: More than 90% of all loads must fall below 110% area (Orange area).
- 2: If necessary due to excessive variation in material density, loader bucket fill-factors or bucket sizes, loading the truck to between 110% and 120% of Nominal Payload is allowed if it accounts for less than 10% of all loads (Yellow area).
- 3: Loading above 120% of Nominal Payload is not allowed. (Red Area)

SOUND LEVEL

Sound level in cab according to ISO 6396LpA 75 dB(A)

ENVIRONMENT

Air conditioner contains fluorinated greenhouse gases, Refrigerant type: HFC-134a, GWP: 1430, Amount: 1.0 kg (2.2 lb.), CO₂e: 1.43 tonnes (1.58 tons).

PERIMETER VISIBILITY (STANDARD)

The addition of mirrors and cameras to the base model make the truck compliant to the perimeter viewing requirement of standards ISO 5006 and ISO 14401.

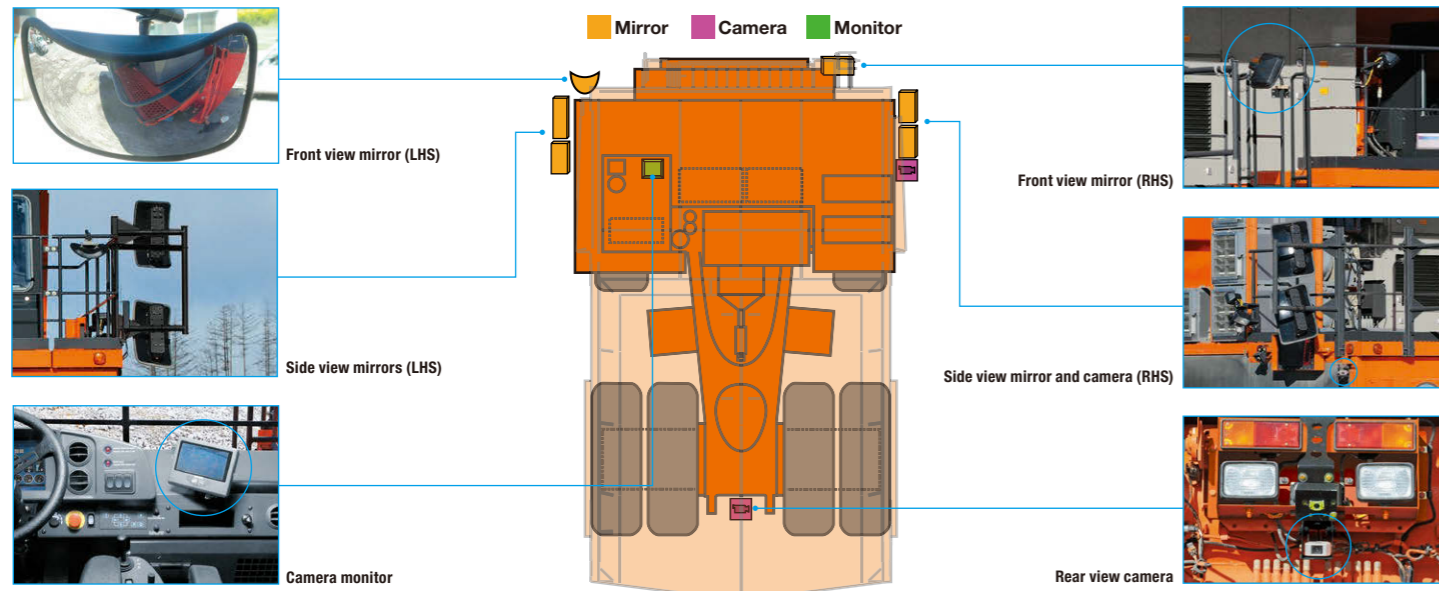

DIMENSIONS

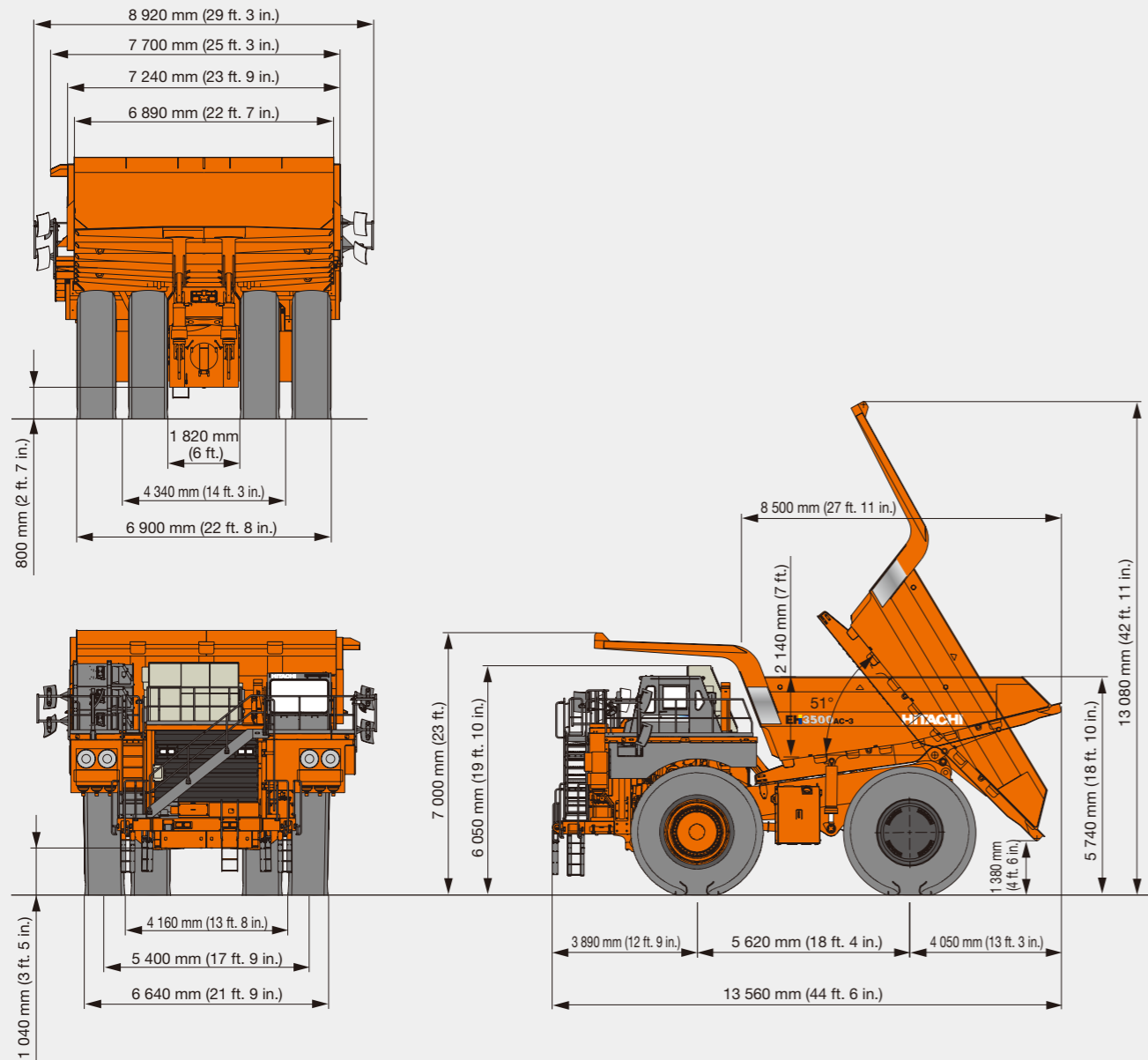

Note: Dimensions shown are for an empty machine with 37.00R57 tires.
Exact dimensions may vary due to tire make, type, and inflation pressure.

EQUIPMENT

STANDARD EQUIPMENT

GENERAL

AC drive system	Front view mirror, LHS/RHS
Auto cruise control	Fuel/Water separator
Auto retarding control	Fuel tank, 2 010 L (531 gal.)
Automatic lubrication system (Lincoln)	Ground level battery box
Battery isolation switch	Ground level relay box
Blower fan motor for Alternator cooling (1)	IGBT controlled blower fan motor for Wheel Motor cooling (1)
Body prop cable	IGBT controlled grid fan motors (4)
Control cabinet pressurized/liquid cooled/ lockable	Load weighing system
Deck mounted muffler	Maximum speed control system according to payload
Deck mounted stone guards	NEOCON suspension struts
Diagonal front stairway	Rear view camera
Electric controlled hoist system	Rear view mirrors (4)
Electric horns (4)	Rims, 29 inch
Emergency ladders (2)	Side view camera (RHS)
Engine access ladders (2)	Suction port shut off valve at hydraulic tank
Engine shutdown switch Beside engine (2)	Supplementary front braking system, accumulator
Ground level, on bumper (1)	Supplementary rear braking system, accumulator
Inside rear axle (1)	Supplementary steering system, accumulator
Fan and belt guards	Tow hooks, front
Fan clutch	Tow lugs, rear
Fast fluid filling system	
Fast fuel filling system provision	
Final drive lubricant cooling	
Final drive lubricant filtration	

CAB

Air conditioner	Load and dump brake switch
Ashtray, cigar lighter	Net Pockets, on door (2)
Auxiliary outlet, 12 volt	Override switch
Camera monitor	Seat
Coat hook	Full size air suspension operator's seat with 3-point, 50 mm (1.97 in.) width seat belt, & automatic weight adjustment
Document Holder	Regular size mechanical suspension trainer's seat with 2-point, 50 mm (1.97 in.) width seat belt
Edge blocks, on tray (3)	Tinted safety glass, with roll-down windows
Engine shutdown switch	Tray, front and rear
FM radio	
Foot rest	
Heater and defroster	
Integral ROPS/FOPS cab	
LCD system monitor	
LED room lights (2)	

INDICATORS AND GAUGES SHOWN ON MONITOR DISPLAY

AC drive system maintenance required warning indicator	Hour meter
Ambient temperature	Hydraulic related warning indicators
Body angle indicator	Indicate HCM code
Brake/steering hydraulic oil pressure gauge	Indicate message
Central warning indicator	Indicate SAE code
Clock	Light indicators
Coolant temperature gauge	Load meter
Drive control status indicator	Model
Drive related warning indicators	Shift lever position indicator
Engine oil pressure gauge	Speedometer (with odometer)
Engine related warning indicators	Stop valve warning indicator
Engine stop warning indicator	Tachometer
Fuel gauge	Turn signal indicator
	Wheel motor temperature gauge

MACHINE LIGHTS

Backup lights (2)	Engine compartment lights (2)
Clearance lights (4)	HID headlights (8)
Combination stop and tail lights (2)	Payload external indicators, 2 locations of 2 lights each
Deck lights (2)	Rear axle compartment light
Diagonal front stairway light	

OPTIONAL EQUIPMENT

Aerial Angle	with 3-point, 50 mm (1.97 in.) width seat belt, & semi-active suspension control
Auxiliary dump connection	Gridbox guard **
Auxiliary steer connection	Halogen front tire lights (2)
Body liners (400BHN)	Heated mirrors
Body prop pins	LED headlights (6)
Body sizes **	LHS refueling system
Cold weather package **	Loadweight displays (2)
Communication system (alternative) *	Smart rim
GPRS communication system	Sound attenuation package **
Satellite data transmitting system	Spare rim
Deck guard	Tire guards (2) **
Fast fluid filling system couplers	Trolley Line Assist
Fast fuel filling system coupler	Trolley system
Fuel tank, 3 640 L (962 gal.)	WIU (Wireless Interface Unit) *
Full size air suspension operator's seat with 3-point, 50 mm (1.97 in.) width seat belt, & semi-active suspension control	
Full size air suspension trainer's seat with 3-point, 50 mm (1.97 in.) width seat belt, & automatic weight adjustment	
Full size air suspension trainer's seat	

* : The availability of the system depends on licensing regulations in each country. Please contact Hitachi dealer for more information.

** : Engineered on request

OPTIONAL EQUIPMENT WEIGHT

Body liners (400BHN) plates including floor & corners (12 mm [0.47 in.] thicknesses), sides & front and canopy (6 mm [0.24 in.] thicknesses)	6 870 kg (15,146 lb.)
3 640 L (962 gal.) fuel tank with 100 % fuel (additional weight to the standard tank with 100 % fuel)	1 900 kg (4,189 lb.)
Arm guard	140 kg (309 lb.)
Deck guard	100 kg (220 lb.)
Loadweight display (2)	150 kg (331 lb.)
Tire guard (2)	130 kg (287 lb.)

Note: Regarding the Cummins engine, fuel optimized ratings available to meet worldwide emissions and enhanced fuel efficiency. Contact your nearest authorized Cummins Distributor for details and availability.



Before using a machine with a satellite communication system, please make sure that the satellite communication system complies with local regulations, safety standards and legal requirements. If not so, please make modifications accordingly.

These specifications are subject to change without notice. Illustrations and photos show the standard models, and may or may not include optional equipment, accessories, and all standard equipment with some differences in color and features. Before use, read and understand the Operator's Manual for proper operation.